



## CorePro LED PLC 4P

### CorePro LED PLC 9W 840 4P G24q-3

The CorePro LED PLC 4P integrates a LED light source into a traditional fluorescent form factor. This product is the ideal solution for uplampping in general lighting applications: it meets basic lighting requirements, offers significant energy savings, and is environmentally friendly.

#### Product data

General Information		Warm Up Time to 60% Light (Nom)	
Cap-Base	G24Q-3 [ G24q-3]	Power Factor (Nom)	0.9
EU RoHS compliant	Yes	Voltage (Nom)	20-50 V
Nominal Lifetime (Nom)	30000 h	<b>Temperature</b>	
Switching Cycle	50000X	T-Ambient (Max)	35 °C
<b>Light Technical</b>		T-Ambient (Min)	-20 °C
Color Code	840 [ CCT of 4000K]	T-Storage (Max)	65 °C
Beam Angle (Nom)	120 °	T-Storage (Min)	-40 °C
Luminous Flux (Nom)	1000 lm	T-Case Maximum (Nom)	76 °C
Color Designation	Cool White (CW)	<b>Controls and Dimming</b>	
Correlated Color Temperature (Nom)	4000 K	Dimmable	No
Luminous Efficacy (rated) (Nom)	100.00 lm/W	<b>Mechanical and Housing</b>	
Color Consistency	<6	Product Length	200 mm
Color Rendering Index (Nom)	83	<b>Approval and Application</b>	
LLMF At End Of Nominal Lifetime (Nom)	70 %	Energy Efficiency Label (EEL)	A+
<b>Operating and Electrical</b>		Energy Saving Product	Yes
Input Frequency	30000-80000 Hz	Approval Marks	TUV CE marking RoHS compliance KEMA Keur certificate
Power (Nom)	9 W		
Lamp Current (Max)	400 mA		
Lamp Current (Min)	250 mA		
Starting Time (Nom)	0.5 s		

## CorePro LED PLC 4P

Energy Consumption kWh/1000 h	12 kWh
<b>Product Data</b>	
Full product code	871869654117300
Order product name	CorePro LED PLC 9W 840 4P G24q-3
EAN/UPC - Product	8718696541173
Order code	929001200902

Numerator - Quantity Per Pack	1
Numerator - Packs per outer box	10
Material Nr. (12NC)	929001200902
Net Weight (Piece)	0.088 kg

## Dimensional drawing

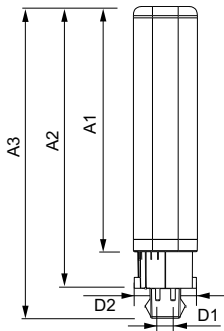

Product	D1	D2	A1	A2	A3
CorePro LED PLC 9W 840 4P G24q-3	24.3 mm	28.4 mm	128.8 mm	148 mm	163.6 mm

LEDtube PLC 9W G24q-3/840 4P

## Photometric data

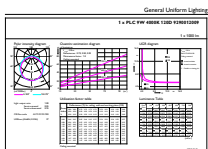

LEDtube PLC 100mm 9W G24Q-3 840 1000lm

LEDtube PLC 100mm 9W G24Q-3 840 1000lm

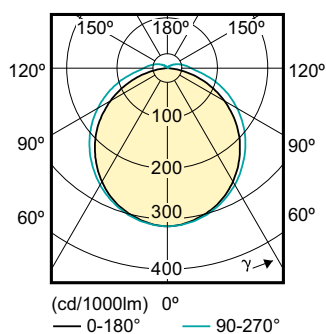

## CorePro LED PLC 4P

### Lifetime

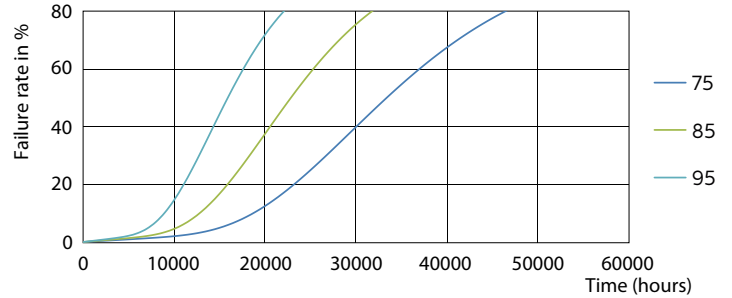
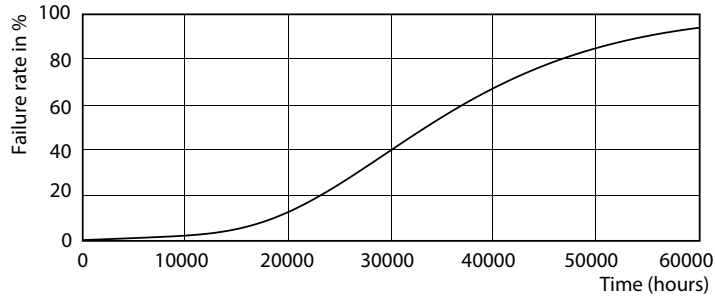

LEDtube PLC 100mm 9W G24Q-3 830 950lm

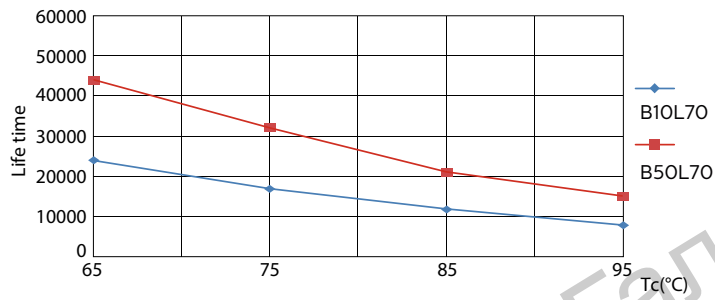

LEDtube PLC 100mm 9W G24Q-3 830 950lm

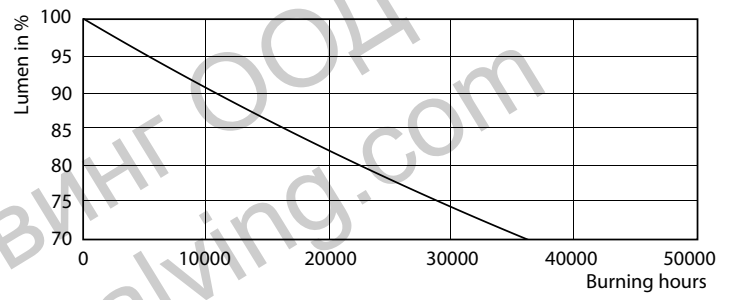

LEDtube PLC 100mm 9W G24Q-3 830 950lm

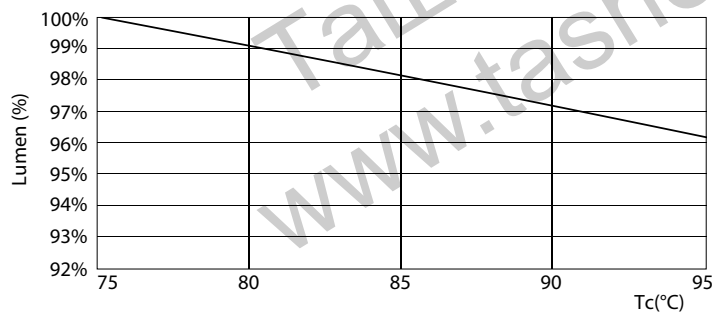

LEDtube PLC 100mm 9W G24Q-3 830 950lm

LEDtube PLC 100mm 9W G24Q-3 830 950lm